









KENMERKEN / FEATURES / MARKMALE

| HL-130 T22 | |
|--|--------------------------|
| H (max.) | ± 12,80 m |
| A (max.) | ± 10,80 m |
| C (min.) | 2,02 m |
| DxF (min.) | 3,21 x 1,74 m |
| ExF (max.) | 4,61 x 1,74 m |
| H1 | 3,18 m |
| H3 | 2,41 m |
| LxB | 3,65 x 2,14 m |
| G | 2,53 m |
| K | 400 mm |
| M | 310 mm |
|  (max.) | 500 kg (2 pers. + 340kg) |
|  (max.) | 500 kg (2 pers. + 340kg) |
|  (sec.) | 44/36 sec. |
|  | 1,6 km/h |
|  | 0,5 km/h |
|  | 6° / 6° |
|  (max.) | ± 35% |
|  | Diesel 22 - 26 kW |
|  KG | 7.020 kg |

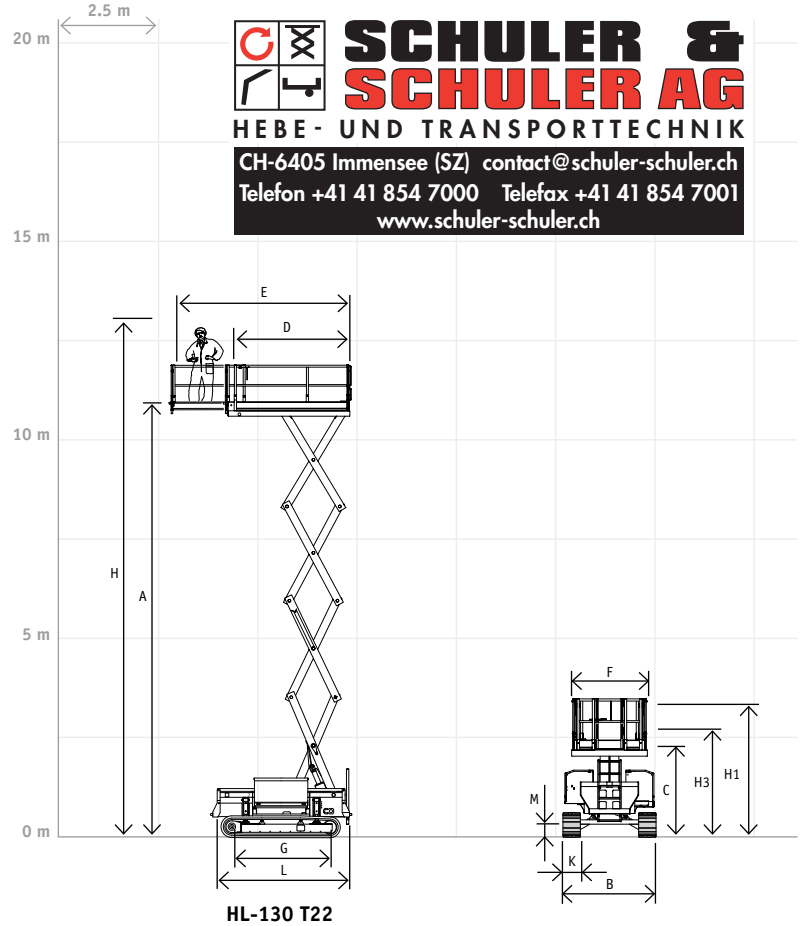

NEDERLANDS

ENGLISH

DEUTSCH

OPTIES

OPTIONS

OPTIONEN

| | | | |
|-------------------------------------|---|---------------------------------------|----|
| Besturing met snelsluitstekker | Controlbox with quick disconnect | Plattformsteuerung mit Schnellstecker | ● |
| Urenteller | Hourmeter | Stundenzähler | ● |
| 230V voorziening op platform | 230V supply on platform | 230V Versorgung an der Plattform | ○ |
| Generator 230V | Generator 230V | Generator 230V | ○ |
| Rijden op volle hoogte | Driving at full height | Fahren in voller Höhe | -- |
| Rijden, proportioneel | Driving, proportional | Fahren, proportional | ● |
| Smeersysteem (Easy Lube, Auto Lube) | Lubrication system (Easy Lube, Auto Lube) | Schmiersystem (Easy Lube, Auto Lube) | ○ |

VEILIGHEIDSVORZIENINGEN

SAFETY FEATURES

SICHERHEITSEINRICHTUNGEN

| | | | |
|------------------------|-------------------|-------------------------|----|
| Beschermhek | Scissor skirt | Schutzgitter | ● |
| Daalbeveiliging | Descent safety | Senkschutz | -- |
| Flitslampen | Flashing beacons | Blinkleuchten | ● |
| Rij-alarm (akoestisch) | Drive alarm | Fahrwarnung (akustisch) | ● |
| Nooddaalvoorziening | Emergency descent | Notsenkvorrichtung | ● |

TOEPASSING

APPLICATION

ANWENDUNG

| | | | |
|---------------------------------------|----------------------------|-------------------------|-------|
| Voor gebruik in gesloten ruimten | Indoors | In geschlossenen Räumen | -- |
| Voor gebruik buiten | Outdoors | Im Freien | ● |
| Toelaatbare min. omgevingstemperatuur | Certified min. temperature | Zul. Tiefsttemperatur | -15°C |

Conversion table

| TYPE | NEW CODE | WORKING HEIGHT (m) | MAX LOAD CAPACITY (kg) | PLATFORM (m) | TOTAL WEIGHT (kg) | SPECIFICATION |
|--------------------|--------------------|--------------------|------------------------|--------------|-------------------|--------------------------------------|
| Z-45EL8 | HL-65 E8 | 6,50 | 220 | 2,21 × 0,77 | 1.065 | Electric |
| Y-64EL8 | HL-84 E8 | 8,40 | 350 | 3,55 × 0,84 | 1.860 | Electric |
| Y-64EL14 | HL-84 E14 | 8,40 | 300 | 3,55 × 1,34 | 2.320 | Electric |
| Y-70DL12-TR | HL-90 T12 | 9,00 | 500 | 4,10 × 1,16 | 3.650 | Diesel, Track |
| XZ-65DXL22-TR | HL-90 TX22 | 8,50 | 750 | 5,90 × 1,95 | 6.540 | Diesel, Track |
| HL-7810 | HL-100 E10 | 9,90 | 450 | 3,24 × 0,98 | 2.380 | Electric, Fold down railing |
| HL-7814 | HL-100 E14 | 9,90 | 450 | 3,34 × 1,20 | 2.440 | Electric, Fold down railing |
| Y-83EL12 | HL-103 E12 | 10,30 | 350 | 3,55 × 1,14 | 2.320 | Electric |
| Y-83EL16 | HL-103 E16 | 10,30 | 350 | 3,55 × 1,55 | 2.760 | Electric |
| X-Z85DL22-TR | HL-110 T22 | 10,60 | 750 | 4,61 × 2,00 | 6.720 | Diesel, Track, Fold down railing |
| HL-9710 | HL-120 E10 | 11,70 | 325 | 3,24 × 0,98 | 2.510 | Electric, Fold down railing |
| HL-9714 | HL-120 E14 | 11,70 | 325 | 3,24 × 1,20 | 2.740 | Electric, Fold down railing |
| X-105EL12 | HL-130 E12 | 12,70 | 650 | 5,05 × 1,17 | 4.780 | Electric, Fold down railing |
| X-105EL16 | HL-130 E16 | 12,70 | 650 | 5,05 × 1,56 | 4.920 | Electric, Fold down railing |
| X-105EL18 | HL-130 E18 | 12,80 | 650 | 5,05 × 1,56 | 4.980 | Electric, Fold down railing |
| X-105DL22-TR | HL-130 T22 | 12,80 | 500 | 4,61 × 1,74 | 7.020 | Diesel, Track, Fold down railing |
| HL-11812 | HL-140 E12 | 13,80 | 300 | 2,34 × 1,20 | 3.200 | Electric, Fold down railing |
| HL-11816 | HL-140 E16 | 13,80 | 300 | 2,34 × 1,40 | 3.260 | Electric, Fold down railing |
| N-140EL12 | HL-160 E12 | 16,00 | 750 | 4,88 × 1,16 | 7.550 | Electric, Fold down railing |
| Q-135EL18 | HL-160 E18 | 15,50 | 750 | 6,06 × 1,78 | 7.280 | Electric, Fold down railing |
| Q-135EL24 | HL-160 E24 | 15,50 | 750 | 6,06 × 2,30 | 7.480 | Electric, Fold down railing |
| Q-135DL24 4WD/P/N | HL-160 D24 4WD/P/N | 15,70 | 750 | 6,06 × 2,30 | 8.710 | Diesel, Fold down railing, 4WD/P/N |
| Q-135DL24-TR | HL-160 T24 | 16,00 | 750 | 6,06 × 2,30 | 10.400 | Diesel, Track, Fold down railing |
| N-165EL12 | HL-190 E12 | 18,50 | 500 | 4,88 × 1,16 | 7.985 | Electric, Fold down railing |
| B-165EL25 | HL-190 E25 | 18,50 | 1000 | 7,00 × 2,30 | 9.980 | Electric, Fold down railing |
| B-165DL25 4WD/P/N | HL-190 D25 4WD/P/N | 18,50 | 1000 | 7,00 × 2,30 | 11.390 | Diesel, Fold down railing, 4WD/P/N |
| N-195EL12 | HL-220 E12 | 21,70 | 500 | 4,88 × 1,16 | 9.120 | Electric, Fold down railing |
| B-195EL25 | HL-220 E25 | 21,70 | 750 | 7,00 × 2,30 | 11.670 | Electric, Fold down railing |
| B-195DL25 4WD/P/N | HL-220 D25 4WD/P/N | 21,70 | 750 | 7,00 × 2,30 | 11.990 | Diesel, Fold down railing, 4WD/P/N |
| B-195HYL25 4WD/P/N | HL-220 H25 4WD/P/N | 21,70 | 750 | 7,00 × 2,30 | 13.500 | Hybrid, Fold down railing, 4WD/P/N |
| T-210DL25 4WD/P/N | HL-235 D25 4WD/P/N | 23,20 | 1000 | 7,32 × 2,40 | 17.950 | Diesel, Fold down railing, 4WD/P/N |
| M-250EL25 4WD/P/N | HL-275 E25 4WD/P/N | 27,50 | 1000 | 8,25 × 2,50 | 23.980 | Electric, Fold down railing, 4WD/P/N |
| M-250DL27 4WD/P/N | HL-275 D27 4WD/P/N | 27,50 | 1000 | 8,25 × 2,50 | 21.910 | Diesel, Fold down railing, 4WD/P/N |
| M-250HYL25 4WD/P/N | HL-275 H25 4WD/P/N | 27,50 | 1000 | 8,25 × 2,35 | 24.980 | Hybrid, Fold down railing, 4WD/P/N |
| N-265EL13 4WDS | HL-285 E13 4WDS | 28,20 | 750 | 7,41 × 1,30 | 18.770 | Electric, Fold down railing, 4WDS |
| N-265EL13 4WDS/N | HL-285 E13 4WDS/N | 28,20 | 750 | 7,41 × 1,30 | 19.370 | Electric, Fold down railing, 4WDS/N |
| N-310EL14 4WDS/N | HL-330 E14 4WDS/N | 33,00 | 600 | 8,40 × 1,20 | 24.000 | Electric, Fold down railing, 4WDS/N |
| G-320EL30 4WDS/N | HL-340 E30 4WDS/N | 33,70 | 1000 | 9,66 × 2,80 | 34.850 | Electric, Fold down railing, 4WDS/N |
| G-320DL30 4WDS/N | HL-340 D30 4WDS/N | 33,70 | 1000 | 9,66 × 2,80 | 31.200 | Diesel, Fold down railing, 4WDS/N |



















**SCHULER &
SCHULER AG**

HEBE- UND TRANSPORTTECHNIK

CH-6405 Immensee (SZ) contact@schuler-schuler.ch

Telefon +41 41 854 7000 Telefax +41 41 854 7001

www.schuler-schuler.ch

| | |
|--|---|
| H (max.) | Werkhoogte Working height Arbeitshöhe |
| H* (max.) | Werkhoogte (op stempels) Working height (on outriggers) Arbeitshöhe (auf Stützen) |
| A (max.) | Max. platformhoogte Max. platform height Max. Plattformhöhe |
| C (min.) | Min. platformhoogte Min. platform height Min. Plattformhöhe |
| DxF (min.) | Platform afmetingen (ingeschoven) Platform dimensions (retracted) Plattformgröße (eingeschoben) |
| ExF (max.) | Platform afmetingen (uitgeschoven) Platform dimensions (extended) Plattformgröße (ausgeschoben) |
| H1 | Transporthoogte Transport height Transporthöhe |
| H2 | Transporthoogte (leuning verwijderd) Transport height (handrail removed) Transporthöhe (Geländer entfernt) |
| H3 | Transporthoogte (leuning neergeklapt) Transport height (handrail folded down) Transporthöhe (Geländer umgeklappt) |
| LxB | Transportafmetingen Transport dimensions Transportabmessungen |
| G | Wielbasis Wheel base Radstand |
| K | Trackbreedte Track width Raupenbreite |
| M/N | Bodemvrijheid Ground clearance Bodenfreiheit |
| ∅ D | Draaistraal uitwendig Turning radius outside Wenderadius Außen |
| ∅ R | Draaistraal inwendig Turning radius inside Wenderadius Innen |
|  (max.) | Max. belasting platform (ingeschoven) Capacity main platform Tragfähigkeit Plattformfestteil |
|  (max.) | Max. belasting platform (uitgeschoven) Capacity roll-out deck Tragfähigkeit Plattformausschub |
|  (sec.) | Hef-/daaltijd (max. last) Lift-/lower time (max. load) Hebe-/Senkzeit (max. Traglast) |
|  | Rijsnelheid (snel) Driving speed (high) Fahrgeschwindigkeit (schnell) |
|  | Rijsnelheid (langzaam) Driving speed (slow) Fahrgeschwindigkeit (langsam) |
|  | Banden, non marking (volrubber) Tyres, non marking (solid rubber) Reifen, non marking (Vollgummi) |
|  | Banden, terrein (schuimgevuld) Tyres, terrain (foamfilled) Reifen, Gelände (ausgeschäumt) |
|  | Banden, tractor (schuimgevuld) Tyres, tractor (foamfilled) Reifen, Traktor (ausgeschäumt) |
|  | Vlakstellen links/rechts (dwars) Levelling left/right (transversal) Quernivellierung (links/rechts) |
|  (max.) | Max. klimvermogen Gradeability Max. Steigfähigkeit |
|  | Batterijcapaciteit (natte cellen) Batteries (traction acid) Batteriekapazität (Traktion Naßzellen) |
|  | Dieselmotor Diesel engine Dieselmotor |
|  | Hybride Hybrid Hybrid |
|  KG | Eigengewicht Gross weight Eigengewicht |
|  | Standaard Standard Standardausrüstung |
|  | Optie Option Option |
| -- | Niet beschikbaar Not available Nicht verfügbar |

